

Register your product and get support at
www.philips.com/welcome



EN User manual 2

DA Brugervejledning 35

DE Benutzerhandbuch 67

ES Manual del usuario 101

FR Mode d'emploi 135

IT Manuale utente 171

NL Gebruiksaanwijzing 205

SV Användarhandbok 237

PHILIPS

Contents

1	Important	4
	Important safety instructions	4
	Notice	8

2	Your portable DVD player	11
	Introduction	11
	What's in the box	12
	Overview of the main unit	12
	Overview of the remote control	15

3	Get started	17
	Charge the battery	17
	Install remote control battery	19
	Connect headphones	20
	Connect additional equipment	20
	Select OSD language	21

4	Use your player	22
	Turn on	22
	Play discs	22
	Adjust volume	22
	Play options	23

5	Adjust settings	26
	Select display ratio	26
	Activate screen saver	26
	Select picture contrast	27
	Get DivX registration code	27

Restrict access	28
Change password	29
Restore original settings	30
<hr/>	
6 Troubleshooting	31
<hr/>	
7 Product information	33

1 Important

Important safety instructions

- ① Read these instructions.
- ② Keep these instructions.
- ③ Heed all warnings.
- ④ Follow all instructions.
- ⑤ Do not use this apparatus near water.
- ⑥ Clean only with dry cloth.
- ⑦ Do not block any ventilation openings. Install in accordance with the manufacturer's instructions.
- ⑧ Do not install near any heat sources such as radiators, heat registers, stoves, or other apparatus (including amplifiers) that produce heat.
- ⑨ For countries with a polarized mains, do not defeat the safety purpose of the polarized or grounding-type plug. A polarized plug has two blades with one wider than the other. A grounding type plug has two blades and a third grounding prong. The wide blade or the third prong are provided for your safety. If the provided plug does not fit into your outlet, consult an electrician for replacement of the obsolete outlet. Caution: To prevent electric shock, match the wide blade of the plug to the wide slot, fully insert.



- ⑩ Protect the power cord from being walked on or pinched, particularly at plugs, convenience receptacles, and the point where they exit from the apparatus.
- ⑪ Only use attachments/accessories specified by the manufacturer.
- ⑫ Use only with the cart, stand, tripod, bracket, or table specified by the manufacturer or sold with the apparatus. When a cart is used, use caution when moving the cart/apparatus combination to avoid injury from tip-over.



- ⑬ Unplug this apparatus during lightning storms or when unused for long periods of time.
- ⑭ Refer all servicing to qualified service personnel. Servicing is required when the apparatus has been damaged in any way, such as power-supply cord or plug is damaged, liquid has been spilled or objects have fallen into the apparatus, the apparatus has been exposed to rain or moisture, does not operate normally, or has been dropped.
- ⑮ **Battery usage CAUTION** – To prevent battery leakage which may result in bodily injury, property damage, or damage to the unit:
 - Install all batteries correctly, + and - as marked on the unit.
 - Do not mix batteries (old and new or carbon and alkaline, etc.).
 - Remove batteries when the unit is not used for a long time.

- ⑩ Apparatus shall not be exposed to dripping or splashing.
- ⑪ Do not place any sources of danger on the apparatus (e.g. liquid filled objects, lighted candles).
- ⑫ This product may contain lead and mercury. Disposal of these materials may be regulated due to environmental considerations. For disposal or recycling information, please contact your local authorities or the Electronic Industries Alliance: www.eiae.org.



Warning

- Never remove the casing of this player.
- Never lubricate any part of this player.
- Never place this player on other electrical equipment.
- Keep this player away from direct sunlight, naked flames or heat.
- Never look into the laser beam inside the player.
- Ensure that you always have easy access to the power cord, plug or adaptor to disconnect the player from the power.

Norge

Typeskilt finnes på apparatens bakside.

Observer: Nettbryteren er sekundert innkoplet.

Den innebygde nettdelen er derfor ikke fraktoplet nettet så lenge apparatet er tilsluttet nettkontakten.

For å redusere faren for brann eller elektrisk støt, skal apparatet, ikke utsettes for regn eller fuktighet.

Hearing safety

Listen at a moderate volume.

- Using headphones at a high volume can impair your hearing. This product can produce sounds in decibel ranges that may cause hearing loss for a normal person, even for exposure less

than a minute. The higher decibel ranges are offered for those that may have already experienced some hearing loss.

- Sound can be deceiving. Over time your hearing 'comfort level' adapts to higher volumes of sound. So after prolonged listening, what sounds 'normal' can actually be loud and harmful to your hearing. To guard against this, set your volume to a safe level before your hearing adapts and leave it there.

To establish a safe volume level:

- Set your volume control at a low setting.
- Slowly increase the sound until you can hear it comfortably and clearly, without distortion.

Listen for reasonable periods of time:

- Prolonged exposure to sound, even at normally 'safe' levels, can also cause hearing loss.
- Be sure to use your equipment reasonably and take appropriate breaks.

Be sure to observe the following guidelines when using your headphones.

- Listen at reasonable volumes for reasonable periods of time.
- Be careful not to adjust the volume as your hearing adapts.
- Do not turn up the volume so high that you can't hear what's around you.
- You should use caution or temporarily discontinue use in potentially hazardous situations. Do not use headphones while operating a motorized vehicle, cycling, skateboarding, etc.; it may create a traffic hazard and is illegal in many areas.



Caution

- Use of controls or adjustments or performance of procedures other than herein may result in hazardous radiation exposure or other unsafe operation.

Notice

Any changes or modifications made to this device that are not expressly approved by Philips Consumer Electronics may void the user's authority to operate the equipment.

Disposal of old equipment and Used batteries

Information for Users on Collection and Disposal of Old Equipment and Used Batteries

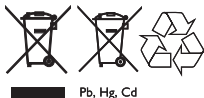

These symbols on the products, batteries, packaging, and/or accompanying documents mean that used electrical and electronic products and batteries should not be mixed with general household waste. For proper treatment, recovery and recycling of old products and used batteries, please take them to applicable collection points, in accordance with your national legislation and the Directives 2002/96/EC and 2006/66/EC.

By disposing of these products and batteries correctly, you will help to save valuable resources and prevent any potential negative effects on human health and the environment which could otherwise arise from inappropriate waste handling.

For more information about collection and recycling of old products and batteries, please contact your local municipality, your waste disposal service or the point of sale where you purchased the items.

Information on Disposal in other Countries outside the European Union

These symbols are only valid in the European Union. If you wish to discard these items, please contact your local authorities or dealer and ask for the correct method of disposal.

Note for the battery symbol



Pb, Hg, Cd

This symbol might be used in combination with a chemical symbol. In this case it complies with the requirement set by the Directive for the chemical involved.

Environmental information

All redundant packing material has been omitted. We have done our utmost to make the packaging easily separable into mono materials. Please observe the local regulations regarding the disposal of packing materials.

Always bring your product to a professional to remove/replace the battery.

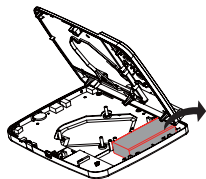

The making of unauthorized copies of copy-protected material, including computer programs, files, broadcasts and sound recordings, may be an infringement of copyrights and constitute a criminal offence. This equipment should not be used for such purposes.

Recording and playback of material might require consent. See Copyright Act 1956 and The Performer's Protection Acts 1958 to 1972.

This player includes this label:



2 Your portable DVD player



Congratulations on your purchase, and welcome to Philips! To fully benefit from the support that Philips offers, register your product at www.philips.com/welcome.

Introduction

Your portable DVD player plays digital video discs that conform to the universal DVD Video standard. With it, you can play movies with true cinema picture quality and stereo or multi-channel sound (depending on disc and playback set-up).

You can also select sound track, subtitle languages, and different angle of view (again depending on DVD disc). Besides, you can restrict the play of discs that are not suitable for children.

You can play the following discs on the DVD player (including CD-R, CD-RW, DVD±R and DVD±RW):

	DVD-Video
	Video CD
	Audio CD



MP3 CD



DivX

Discs with JPEG files

What's in the box

Check and identify the contents of your package:

- Portable DVD player
- Remote control
- AC power adaptor; DSA-9W-09 F (DVE) or AY4132 (Philips)
- Car adaptor
- AV cables
- User Manual
- Quick Start Guide

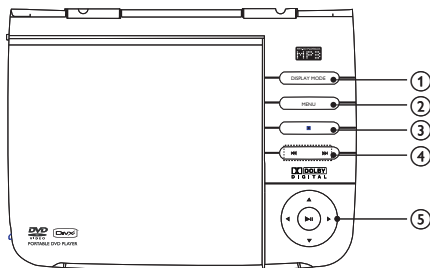

Overview of the main unit

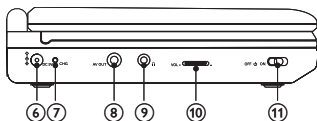

- ① **DISPLAY MODE**
- Transmit video to the device connected to the **AV OUT** jack.
- ② **MENU**
- For DVD, access or exit disc menu.
 - For VCD, turn on or off PBC (Playback Control) mode.
- ③ ■
- Stop disc play.
- ④ ⏮, ⏭
- Skip to the previous or next title/chapter/track.
- ⑤ ▲, ▼, ◀, ▶
- Move cursor up/down/left/right.
- ◀, ▶
- Search backward or forward at different speeds.
- ▶||
- Confirms an entry or selection.
 - Start or pause disc play.



- ⑥ **DC 9V**
- Power supply socket.
- ⑦ **CHG**
- Charge indicator.
- ⑧ **AV OUT**
- Audio/video output jack.

- ⑨  Headphone jack.
- ⑩ VOL +/-
• Adjust the volume level.
- ⑪ OFF  ON
• Turn DVD player on/off.

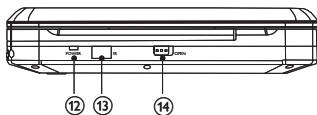

- ⑫ POWER
• Power indicator.
- ⑬ IR
• Remote control sensor.
- ⑭ OPEN
• Open the disc compartment.

Overview of the remote control

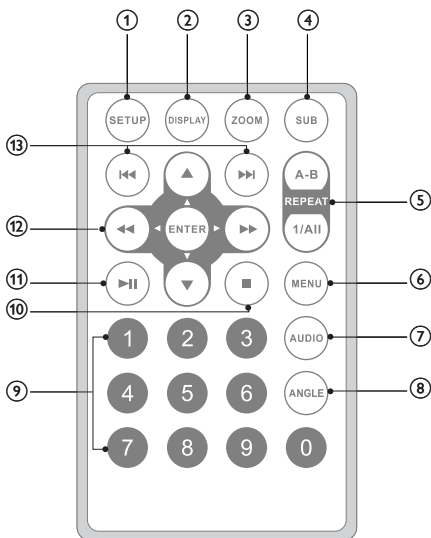

- ① **SETUP**
 - Access or exit the setup menu.
- ② **DISPLAY**
 - Display play information.
- ③ **ZOOM**
 - Zoom in or out.
- ④ **SUB**
 - Select DVD subtitle language.

⑤ **A-B REPEAT**

- Mark the section for repeat play.

REPEAT 1/ALL

- Repeat a chapter/track/title.

⑥ **MENU**

- For DVD, access or exit disc menu.
- For VCD, turn on or off PBC (Playback Control) mode.

⑦ **AUDIO**

- For DVD, select an audio language.
- For VCD, select an audio mode.

⑧ **ANGLE**

- Select a different viewing angle of a DVD.

⑨ **Numeric Keypad 0 - 9**

- Input numbers.

⑩ **■**

- Stop disc play.

⑪ **▶ ||**

- Start or pause disc play.

⑫ **▲, ▼, ◀◀, ▶▶**

- Move cursor up/down/left/right.

◀◀, ▶▶

- Search backward or forward at different speeds.

ENTER

- Confirms an entry or selection.

⑬ **◀◀, ▶▶**

- Skip to previous/next chapter, track or title.

3 Get started



Caution

- Use the controls only as stated in this user manual.

Always follow the instructions in this chapter in sequence. If you contact Philips, you will be asked for the model and serial number of your player. Find the model number and serial number of this player at the back or the bottom of your player; write these numbers here:

Model No. _____

Serial No. _____

Charge the battery



Caution

- Risk of product damage! Ensure that the power supply voltage corresponds to the voltage printed on the back or the underside of the player.
- The type plate is located on the bottom of the player.
- Use only the supplied AC adaptor to charge the battery.

- 1 Slide the **OFF**↻**ON** switch to **OFF** position.

- 2 Connect the supplied AC adaptor to the player and to the AC outlet.

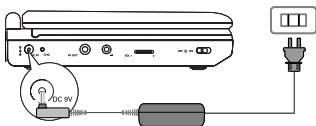

- ↳ The charge indicator turns on. It takes about 4.5 hours to fully charge the battery.
- ↳ When the battery is fully charged, the charge indicator turns off.



Tip

- You can only charge the battery when the temperature is between 32°F (0°C) and 95°F (35°C).
- When headphones are connected to the DVD player, the fully charged battery lasts about 2 hours.
- When the power is low, the battery icon is shown on the upper-left corner of the screen for warning.
- To maximize battery life, recharge the battery immediately once the battery is fully discharged. If you do not use the player for a long time, recharge the battery once every two months.

Install remote control battery



Caution

- Risk of explosion! Keep batteries away from heat, sunshine or fire. Never discard batteries in fire.
- Risk of decreased battery life! Never mix different brands or types of batteries.
- Risk of product damage! When the remote control is not used for long periods, remove the batteries.
- Perchlorate Material - special handling may apply. See www.dtsc.ca.gov/hazardouswaste/perchlorate.

For first-time use:

- Remove the protective tab to activate the remote control battery.

To replace the remote control battery:

- 1 Open the battery compartment.
- 2 Insert 1 CR2025 battery with correct polarity (+/-) as indicated.
- 3 Close the battery compartment.

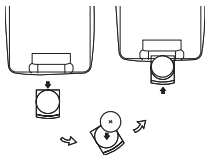

Connect headphones

Plug the headphones into the  jack of the player.

Connect additional equipment



Caution

- Turn off your player before connecting to any additional equipment.

You can connect the player to a TV or an amplifier to enjoy DVDs or Karaoke.

- Connect a TV

Match the color of the AV cables (not supplied) with the jacks: the yellow cable is for the yellow video jack, the red/white cable is for the red/white audio jacks.

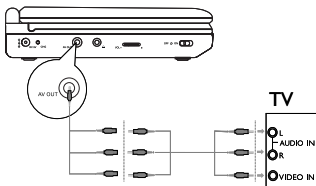

Select OSD language

You can choose a different language for the on-screen display text.

- 1 Press **SETUP**.
↳ The setup menu is displayed.

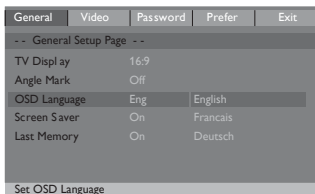

- 2 Select [-- General Setup Page --] > [OSD Language].
- 3 Press ►► to select an option.
- 4 Press **ENTER** to confirm.
- 5 Press **SETUP** to exit.

4 Use your player

Turn on

Slide the **OFF**  **ON** switch to the **ON** position.

- The **POWER** indicator turns on.

Play discs

1 Press **OPEN** on the player.

2 Insert the disc with label side facing up.

3 Push down to close the disc compartment.

↳ Play starts automatically. If not, press **▶||**.

- If a menu appears, select an item, then press **▶||** to start play.
- To pause, press **▶||**. Press again to resume play.
- To view disc information, press **DISPLAY**.
- To stop, press **STOP**  twice.

Adjust volume

Adjust the volume control on the left side of the player.

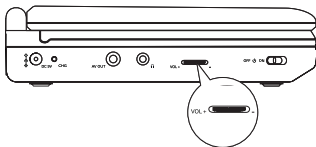

Play options

Skip to a title/track/chapter

- To select the previous/next title, track or chapter, press **◀◀** or **▶▶**.
- To skip directly to any title/track/chapter, enter the corresponding number with the numerical keys (0-9), then press **ENTER**.

Search

- During play, press **◀◀▶▶** to select a search speed.
- Press **▶||** or **ENTER** to resume normal play.

Select audio language

For DVDs that contain two or more audio languages.

- During play, press **AUDIO** repeatedly until the language is selected.

Select subtitle language

For DVDs that contain two or more subtitle languages.

- During play, press **SUB** repeatedly until the language is selected.

Repeat

- During play, press **REPEAT 1/ALL** repeatedly to select the following repeat options:

For DVD

- [**⏮** Chapter]
- [**⏮** Title]

- [⏮ ALL]
- [Repeat Off]

For VCD

- [⏮ Track]
- [⏮ ALL]
- [Repeat Off]

For CD/MP3/JPEG/DivX

- [Repeat One]
- [Repeat Folder]
- [Repeat Off]



Tip

- For VCDs, if PBC is on, you cannot repeat items.

Repeat a section

You can repeat a specific section of audio/video within a title/chapter/track (repeat A-B).

- 1 During play, at the chosen start point, press **A-B REPEAT**.
↳ [⏮ A] is displayed.
- 2 At the chosen end point, press **A-B REPEAT** again.
↳ [⏮ AB] is displayed.
↳ The selected section plays repeatedly.
- 3 Press **A-B REPEAT** to cancel.

Zoom

For DVDs, VCDs and JPEG CDs, you can zoom in and out for video images or pictures.

- 1 Press **ZOOM** repeatedly to zoom in and out.
- 2 When the video image or picture is enlarged, press ▲, ▼, ►, ◀ to pan through it.

Select audio mode

When you play VCDs, you can select an audio mode.

- Press **AUDIO** repeatedly to select audio channel: [**Mono Left**], [**Mono Right**], or [**Stereo**].

Rotate pictures

For JPEG CDs only. While the JPEG is displayed:

- Press ◀◀ to rotate counter-clockwise.
- Press ►► to rotate clockwise.
- Press ▲ to flip up/down.
- Press ▼ to flip left/right..

5 Adjust settings

Select display ratio

- 1 Press **SETUP**.
- 2 Select [-- General Setup Page --] > [TV Display].
- 3 Press ►► to select an option.
 - **[4:3 PS]**: The top and bottom or the sides of the picture are trimmed. The picture is not distorted.
 - **[4:3 LB]**: Black bars may appear on the top and bottom or the sides of the picture. The picture is not distorted.
 - **[16:9]**: The picture is displayed in the original proportion of images transmitted in 16:9 format and distorted.
- 4 Press **ENTER** to confirm.
- 5 Press **SETUP** to exit.

Activate screen saver

If you do not press any buttons five minutes after the play is stopped, screen saver starts automatically.

- 1 Press **SETUP**.
- 2 Select [-- General Setup Page --] > [Screen Saver].
- 3 Press ►► to select an option:
 - **[On]**: Activate screen saver.
 - **[Off]**: Deactivate screen saver.
- 4 Press **ENTER** to confirm.
- 5 Press **SETUP** to exit.

Select picture contrast

- 1 Press **SETUP**.
- 2 Select [-- Video Setup Page --] > [**Brightness**] or [**Contrast**].
- 3 Press **▶▶**.
↳ A confirmation box is displayed.



Brightness 0

- 4 Press **◀▶▶** to set brightness and contrast.
- 5 Press **ENTER** to confirm.
- 6 Press **SETUP** to exit.

Get DivX registration code

DivX is a popular media technology created by DivX, Inc. DivX media files contain highly compressed video with high visual quality that maintains a relatively small file size. DivX files can also include advanced media features like menus, subtitles, and alternate audio tracks. Many DivX media files are available for download online, and you can rent and purchase DivX videos with the DivX VOD (Video on Demand) service. To use this service, you need the DivX VOD registration code of this player. For more information and instructions, visit www.divx.com/vod.

- 1 Press **SETUP**.
- 2 Select [-- Video Setup Page --] > [**DivX VOD**].
- 3 Press **▶▶** to select [**OK**].
- 4 Press **ENTER**.
↳ The DivX registration code appears.

- 5 Write down the number for future reference.
- 6 Press **ENTER** to exit.



"DivX, DivX" Certified, and associated logos are trademarks of DivX, Inc. and are used under license.

Official DivX® Certified product. Plays all versions of DivX® video (including DivX® 6) with standard playback of DivX® media files.

Restrict access

Depending on the DVD, you may be asked to change the parental level while playing the disc. The rating levels are from 1 to 8 and are country dependent. You can prohibit the playing of certain discs that are not suitable for your children, or have certain discs played with alternative scenes.

- 1 Press **SETUP**.
- 2 Select **[-- Preference Page --] > [Parental]**.
- 3 Press **▶▶** to select an option:
 - **[1 KID SAF]**: Childsafe; acceptable for viewers of all ages.
 - **[2 G]**: General Audience; recommended as acceptable for viewers of all ages.
 - **[3 PG]**: Parental Guidance suggested.
 - **[4 PG 13]**: Unsuitable for children under age 13.
 - **[5 PGR]**: Parental Guidance; recommended that parents restrict children under 17 from viewing.
 - **[6 R]**: Restricted; recommended only when supervised by a parent or adult guardian.

- **[7 NC17]**: No Children under age 17; not recommended viewing for children under age 17.
- **[8 ADULT]**: Mature Material; should be viewed only by adults.

- 4** Press **ENTER**.
↳ You are prompted to enter the password.
- 5** Press **ENTER** to confirm.
- 6** Press **SETUP** to exit.

**Tip**

- For how to change the password, see "Change password".

Change password

- 1** Press **SETUP**.
- 2** Select [-- Password Change Page --] > [Password].
- 3** Press ►► to select [Change].
- 4** Press **ENTER**.
- 5** Enter the current password.
 - For the first time, enter 3308 as the password.
- 6** Enter a new 4-digit password twice.
- 7** Press **ENTER** to confirm.
- 8** Press **SETUP** to exit.

**Tip**

- If you forget your password, enter 3308.

Restore original settings

- 1 Press **SETUP**.
- 2 Select [-- Preference Page --] > [Default].
- 3 Press ►► to select [**Reset**].
- 4 Press **ENTER** to confirm.

6 Troubleshooting



Warning

- Risk of electric shock. Never remove the casing of this player.

To keep the warranty valid, never try to repair the system yourself. If you encounter problems when using this player, check the following points before requesting service. If the problem remains unsolved, register your player and get support at www.philips.com/welcome.

No power

- Ensure that both plugs of the mains cord are properly connected.
- Ensure that there is power at the AC outlet.
- Check if the built-in battery is drained.

Distorted picture

- Clean the disc. With a clean, soft, lint-free cloth, wipe the disc outwards from the center.
- Make sure that the video output format of the disc is compatible with the TV.
- Change the video output format to match your TV or program.
- The LCD is manufactured using high precision technology. You may, however, see tiny black points and/or bright points (red, blue, green) that continuously appear on the LCD. This is a normal result of the manufacturing process and does not indicate a malfunction.

No sound

- Ensure that the AV cable is connected correctly.

Cannot play disc

- Ensure the disc label is upwards.
- Clean the disc. With a clean, soft, lint-free cloth, wipe the disc outwards from the center.
- Check if the disc is defective by trying another disc.

No response to the remote control

- Ensure that the path between the remote control and the player is clear from obstacles.
- From a close distance, point the remote control directly at the player.
- Replace the remote control batteries.
- The function does not work for this disc. Refer to the disc instructions.

The player feels warm

- When the player is in use for a long period of time, its surface will be heated. This is normal.

7 Product information



Note

- Product information is subject to change without prior notice.

Dimensions	210 x 178 x 39 mm
Weight	0.79 kg/0.36 pounds
Power supply	Input: 100-240V 50/60Hz 0.3A Output: DC 9V 1A
Power consumption	9 W
Operating temperature range	0-45°C
Laser wavelength	650 nm
Video system	PAL
Frequency response	20Hz-20KHz \pm 1dB
Signal/noise ratio	\geq 80 dB
Audio distortion + noise	\leq -80 (1KHz)
Channel separation	\geq 80 dB
Dynamic range	\geq 80 dB
Audio out (analog audio)	Output level: 2V \pm 10%
Load impedance	10 K Ω
Video out	Output level: 1V _p - p \pm 20%
Load impedance	75 Ω

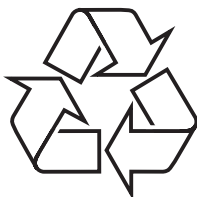

© 2008 Koninklijke Philips Electronics N.V.

All rights reserved.